

AC/DC Converter

PVA40-26Bxx Series

MORNSUN®

40W isolated AC-DC converter with ultra-wide, ultra-high 460 - 1500VAC input for coalmine



RoHS

FEATURES

- Specially designed for electrical equipment in coal mining industry
- Ultra-wide 460 - 1500VAC input voltage range
- Industrial grade operating temperature: -25°C to +70°C
- High I/O isolation test voltage of 4200VAC
- Ultra-low input impulse current
- High reliability, high efficiency, long lifespan
- Output short circuit, over-current and over-voltage protection

PVA40-26Bxx series is a special power supply designed for customers who provide electrical equipment for coal mining industry to meet the requirements of safety in providing power supply, easy mounting and technology innovation etc. It features ultra-wide input voltage range from 460 to 1500VAC which covers 660/1140VAC used in coal mining industry, high isolation voltage, multiple protections and high efficiency. They are widely used in monitoring and security sectors of coal mining industry.

Selection Guide

Part No.	Output Power	Nominal Output Voltage and Current (Vo/Io)	Efficiency at 660VAC (%) Typ.	Capacitive Load (μF) Max.
PVA40-26B12	40W	12V/3400mA	82	5000
PVA40-26B28	40W	28V/1430mA	85	2200
PVA40-26B35	40W	35V/1150mA	85	1600

Input Specifications

Item	Operating Conditions	Min.	Typ.	Max.	Unit
Input Voltage Range		460	--	1500	VAC
Input Current	460VAC	--	--	0.2	A
	1400VAC	--	--	0.11	
Inrush Current	460VAC	--	10	--	
	1400VAC	--	30	--	
External input Fuse		1A/1200VAC, required			
Hot Plug		Unavailable			

Output Specifications

Item	Operating Conditions	Min.	Typ.	Max.	Unit	
Output Voltage Accuracy	All load range	--	±2	--	%	
Line Regulation	Rated load	--	±0.5	--		
Load Regulation	10% - 100% load	--	±1	--		
Ripple & Noise*	20MHz bandwidth (peak-to-peak value)	--	--	200	mV	
Temperature Coefficient		--	±0.02	--	%/°C	
Short Circuit Protection		Hiccup, continuous, self-recovery				
Over-current Protection		≥ 110%Io, hiccup, self-recovery				
Over-voltage Protection	12V output	≤ 18VDC (Output voltage clamp or hiccup or turn off)				
	28V output	≤ 40VDC (Output voltage clamp or hiccup or turn off)				
	35V output	≤ 45VDC (Output voltage clamp or hiccup or turn off)				
Minimum Load		0	--	--	%	
Hold-up Time	Room temperature, full load	660VAC input	--	10	--	ms
		1100VAC input	--	50	--	
Start-up Delay Time		--	--	1	s	

Note: * The "parallel cable" is used for ripple and noise test, please refer to PV Converter Application Notes for specific information.

MORNSUN®

MORNSUN Guangzhou Science & Technology Co., Ltd.

2020.11.06-A/2

Page 1 of 4

MORNSUN Guangzhou Science & Technology Co., Ltd. reserves the copyright and right of final interpretation

General Specifications

Item	Operating Conditions		Min.	Typ.	Max.	Unit
Isolation	Input - output	Electric Strength Test for 1min., leakage current $\leq 5\text{mA}$	4200	--	--	VAC
	Input - PE		4200	--	--	
	Output - PE		4200	--	--	
Insulation Resistance	500VDC	$\geq 50 \times 10^6$			Ω	
Operating Temperature		-25	--	+70	$^{\circ}\text{C}$	
Storage Temperature		-40	--	+85		
Storage Humidity		--	--	95	%RH	
Power Derating	+50 $^{\circ}\text{C}$ to +70 $^{\circ}\text{C}$		2.0	--	--	%/ $^{\circ}\text{C}$
	1300VAC-1500VAC		0.2	--	--	%/VAC
Switching Frequency		--	65	--	kHz	
MTBF		MIL-HDBK-217F@25 $^{\circ}\text{C}$ $\geq 300,000$ h				

Mechanical Specifications

Case Material	metal
Dimensions	144.50 x 105.00 x 40.00mm
Weight	400g(Typ.)
Cooling method	Free air convection

Electromagnetic Compatibility (EMC)

Immunity	ESD	IEC/EN61000-4-2	Contact $\pm 6\text{KV}$ /Air $\pm 8\text{KV}$	perf. Criteria B
----------	-----	-----------------	--	------------------

Product Characteristic Curve

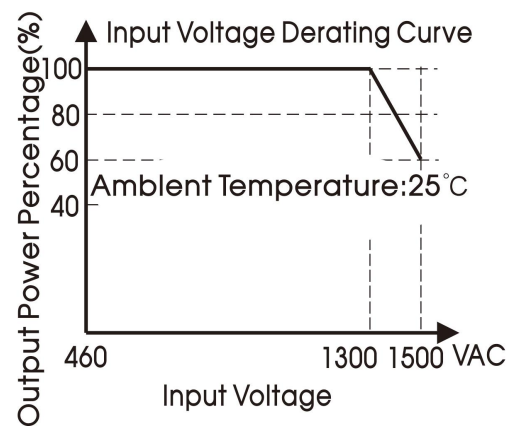
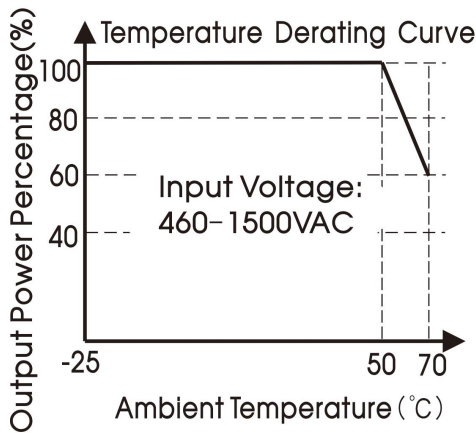

Note: ① With an input between 1300 - 1500VAC, the output power must be derated as per temperature derating curves;

② This product is suitable for applications using natural air cooling; for applications in closed environment please consult factory or one of our FAE.

Efficiency Vs Input Voltage (Full Load)

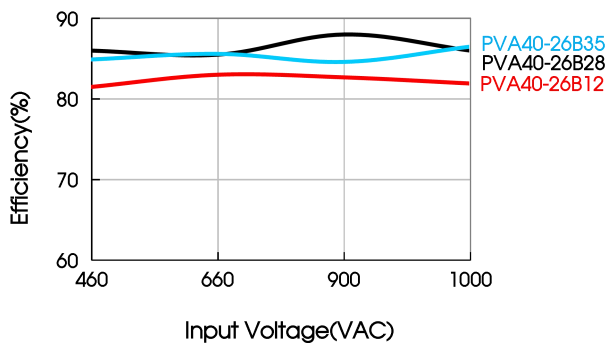

Efficiency Vs Output Load (Vin=660VAC)

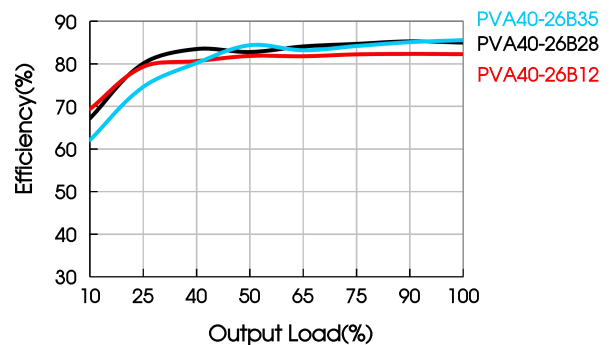

Design Reference

1. Trim Function for Output Voltage Adjustment (open if unused)

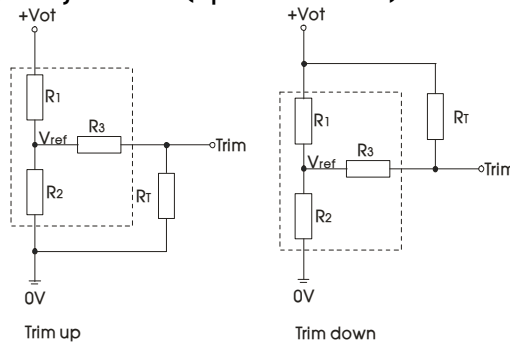

TRIM resistor connection (dashed line shows internal resistor network)

Calculating Trim resistor values:

$$\text{up: } R_T = \frac{\alpha R_2}{R_2 - \alpha} \cdot R_3 \quad \alpha = \frac{V_{ref}}{V_{ot} - V_{ref}} \cdot R_1$$

$$\text{down: } R_T = \frac{\alpha R_1}{R_1 - \alpha} \cdot R_3 \quad \alpha = \frac{V_{ot} - V_{ref}}{V_{ref}} \cdot R_2$$

R_T = Trim Resistor value;
 α = Self-defined parameter;

V _{out}	R1(K Ω)	R2(K Ω)	R3(K Ω)	V _{ref} (V)	V _{ot} (V)
12V	8.66	2.265	1	2.5	Resulting trimmed output voltage, range $\leq \pm 10\%$
28V	12.4	1.2	1	2.5	
35V	12.4	0.942	1	2.5	

2. For more information Please find the application notes on www.mornsun-power.com

Dimensions and Recommended Layout

THIRD ANGLE PROJECTION 

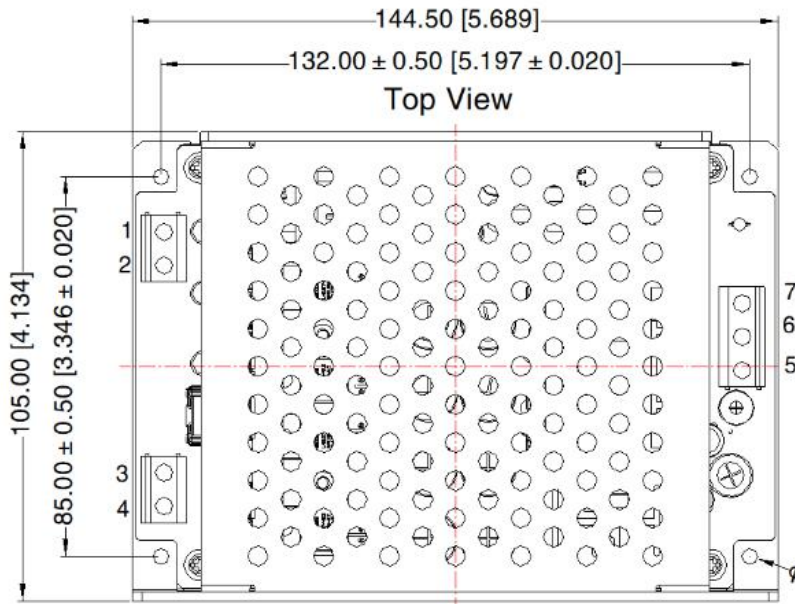

Pin-Out	
Pin	Mark
1	AC(L)
2	AC(L)
3	AC(N)
4	AC(N)
5	+Vo
6	-Vo
7	Trim

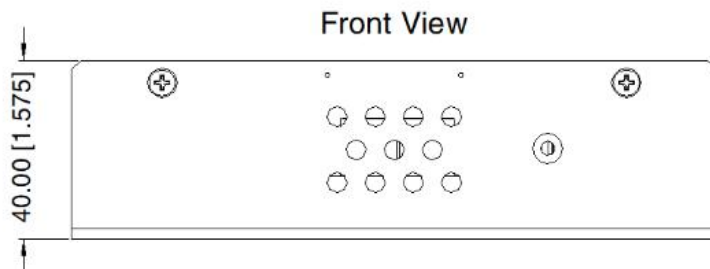

Note:
Unit: mm[inch]
Wire range: 24~12AWG
Tightening torque: Max 0.4N·m
General tolerances: ± 1.00[± 0.039]

Note:

1. For additional information on Product Packaging please refer to www.mornsun-power.com. Packaging bag number: 58220039;
2. Unless otherwise specified, parameters in this datasheet were measured under the conditions of $T_a=25^{\circ}\text{C}$, humidity<75% with nominal input voltage and rated output load;
3. All index testing methods in this datasheet are based on our company corporate standards;
4. We can provide product customization service, please contact our technicians directly for specific information;
5. Products are related to laws and regulations: see "Features" and "EMC";
6. Our products shall be classified according to ISO14001 and related environmental laws and regulations, and shall be handled by qualified units.

Mornsun Guangzhou Science & Technology Co., Ltd.

Address: No. 5, Kehui St. 1, Kehui Development Center, Science Ave., Guangzhou Science City, Huangpu District, Guangzhou, P. R. China
Tel: 86-20-38601850 Fax: 86-20-38601272 E-mail: info@mornsun.cn www.mornsun-power.com