



Typical Features

- ◆ Fixed input voltage, Isolated & regulated output, 1W
- ◆ High Efficiency up to 79%
- ◆ Small compact SIP packing
- ◆ No external component required
- ◆ Isolation Voltage 3000VDC
- ◆ Operating Temperature: -40°C~+85°C
- ◆ Plastic Case, meet UL94 V-0 standard



Test Condition: Unless otherwise specified, data in the datasheet should be tested under the conditions of inputting nominal voltage, pure resistance rated load and Ta=25°C

Application Field

It could be widely used for instrument, communication, pure digital circuit, general low frequency analog circuit, relay drive circuit, data exchange circuit, etc.

Typical Product List

Model	Input Voltage Range (VDC)		Output Voltage/Current (Vo/Io)		Input Current(mA) Nominal Voltage		Max. Capacitive Load uF	Ripple & Noise (Max.) mVp-p	Efficiency (%)full load, input nominal voltage	
	Nominal	Range	Voltage (VDC)	Current(mA) MAX./Min.	Full load Typ.	No Load Typ.			Min.	Typ.
FW1-05S3V3B3	5	4.75 - 5.25	3.3	303	290	30	3000	100	67	69
FW1-05S05B3			5	200	279	29	3000	100	69	71
FW1-05S12B3			12	83	256	23	3000	100	76	78
FW1-05S15B3			15	67	256	30	3000	100	75	77
FW1-05S24B3			24	42	276	40	3000	100	71	73
FW1-12S05B3	12	11.4 - 12.6	5	200	109	10	3000	100	75	77
FW1-12S12B3			12	83	104	10	3000	100	77	79
FW1-12S15B3			15	67	103	11	3000	100	72	74
FW1-24S05B3	24	22.8 - 25.2	5	200	57	7	3000	100	72	74
FW1-24S12B3			12	83	60	11	3000	100	74	76
FW1-24S15B3			15	67	53	8	3000	100	75	77
FW1-24S24B3			24	42	63	13	3000	100	65	67

Note:
In order to ensure the converter can work reliably with high efficiency, the minimum load should not less than 10% rated load when it is used. If the needed power is indeed small, please parallel a resistor at the output side, the resistance recommended equal to 10% nominal power.



Input Specifications

Item	Working Conditions	Min.	Typ.	Max.	Unit
Input Overshoot Voltage (1Second.max.)	5Vdc Input	-0.7	-	9	Vdc
	12Vdc Input	-0.7	-	18	
	24Vdc Input	-0.7	-	30	
Input Filter	Capacitor Filter				

Output Specifications

Item	Working Conditions	Min.	Typ.	Max.	Unit
Output Power		0.1	--	1	W
Output Voltage Accuracy	Nominal input, Full load	--	±2	±3	%
Load Regulation	10% ~ 100% nominal load	--	--	1.0	
Line Regulation	Input Voltage Change±1%	--	--	±0.25	
Ripple & Noise①	Nominal input,full load, 20MHZ bandwidth	--	75	100	mVp-p
Temperature Drift Coefficient	100% Full Load	--	--	±0.03	%/°C
Output Short Circuit Protection②	Continuous, self-recovery				

NOTE:①Ripple & Noise tested by twisted-pair method.

General Specifications

Switching Frequency	Typical	100KHz (Typ.)
Operating Temperature	Refer to Temperature Derating Curve	-40°C ~ +85°C
Storage Temperature		-55°C ~ +125°C
Shell temperature rise during work	Within Temperature Derating Curve	25°C(Typ.)
Relative Humidity	No condensing	5%~95%
Case Material		Black flame-retardant heat-resistant Plastic(UL94 V-0)
Pin Withstand Soldering Temp	Distance to case 1.5mm, 10S	300°C MAX
Isolation Voltage	Test 1 minute, leakage current< 0.5mA	3000Vdc
Isolation Capacitor	Input/Output,100KHz/0.1V	20 pF (Typ.)
MTBF	MIL-HDBK-217F@25°C	35X10 ⁵ Hrs
Product Weight		2.1g(Typ.)
Packing	Tube(525*18*10mm)	25PCS
	Box(542*110*155mm)	2000PCS(Total 80 Tubes)

/



Packing Dimension

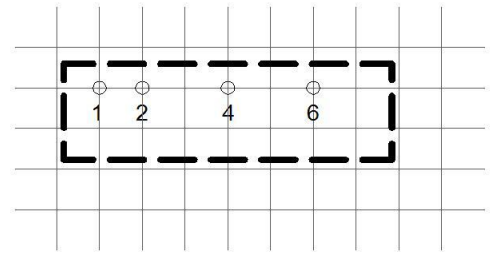
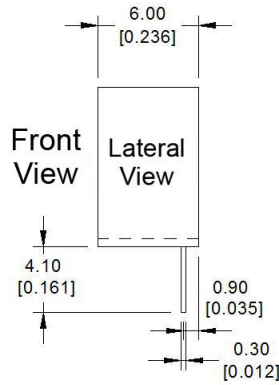
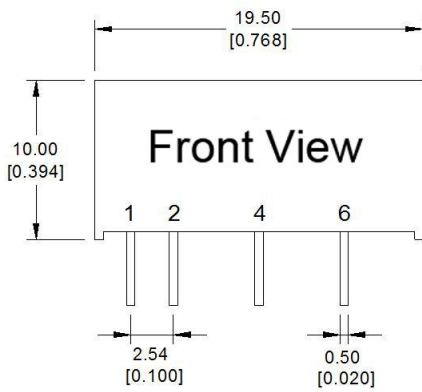

Print board vertical view
Grid: 2.54mm(0.1inch)

Unit: mm(inch)
General tolerance: 0.XX±0.1(0.XX±0.004)
0.XX±0.25(0.XX±0.01)

Packing Code	L x W x H	
B	19.50x 6.00 x 10.00mm	0.768 x 0.236 x 0.394inch

Pin Function

Pin Function	1	2	3	4	5	6
Single(S)	+Vin	GND	NP	-Vo	NP	+Vo

Note: if the definition of pin is not in accordance with the model selection manual, please refer to the label on actual item.

Ripple & Noise Test: (Twisted Pair Method 20MHZ bandwidth)

Test Method:

a. 12# twisted pair to connect, Oscilloscope bandwidth set as 20MHz, 100M bandwidth probe, terminated with 0.1uF polypropylene capacitor and 10uF high frequency low resistance electrolytic capacitor in parallel, oscilloscope set as Sample pattern.

b. Input terminal connect to power supply, output terminal connect to electronic load through jig plate, Use 30cm±2 cm sampling line, Power line selected from corresponding diameter wire with insulation according to the flow of output current.

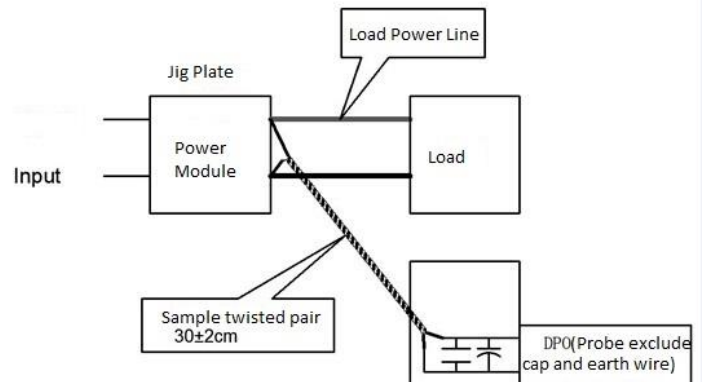

Temperature Curve

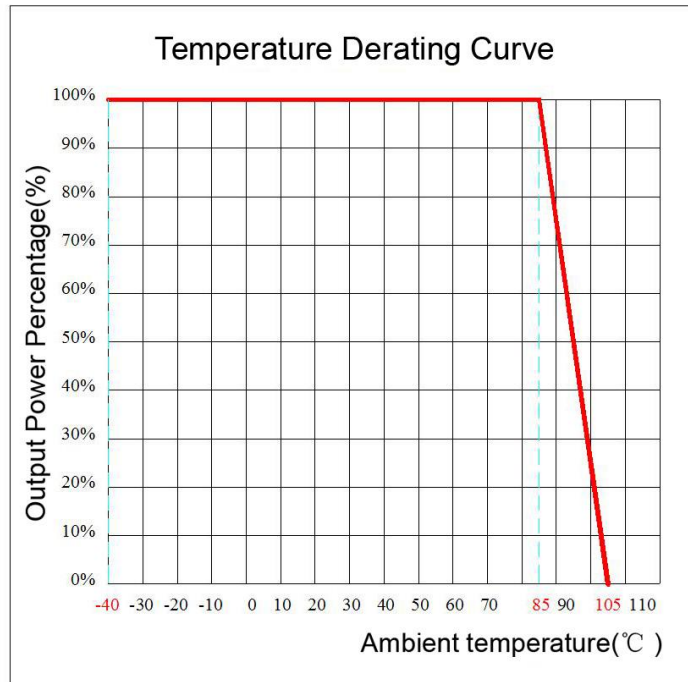

Design and Application Circuit Recommended

1. Output load requirements

- a. In order to ensure the converter can work reliably with high efficiency, the minimum load should not less than 10% rated load when it is used. If the needed power is indeed small, please parallel a resistor at the output side, the resistance equal to 10% nominal load.
- b. The maximum capacitive load is tested under nominal input full load, and cannot exceed the maximum capacitive load of output terminal under operation, otherwise it will cause it difficult to start up and damage the product.

2. Recommended circuit

In order to ensure the input/output ripple and noise decreased, capacitor filter net could be connected to input and output terminal, application circuit as below photo 1; choosing suitable filter capacitor is very important, start-up problems may be caused by too large capacitance. To ensure the modules running safely and reliably, the recommended capacitive load values as shown in Table 1. (But for the actual output power of application circuit is less than 0.5W, suggest not to connect external capacitor)

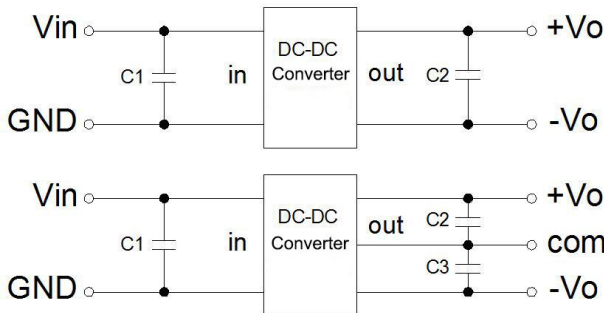

Recommended capacitive load value (Table 1)

Vin (Vdc)	C1 (μF)	Vout (Vdc)	C2 (μF)	Vout (Vdc)	C2,C3 (μF)
3.3/5	4.7	3.3/5	10	±3.3/±5	4.7
12	2.2	9	4.7	±9	2.2
15	1	12	2.2	±12	1
24	1	15	1	±15	0.47
--	--	24	0.47	±24	0.22



3. Output regulated voltage and over voltage protection circuit

The simplest device to protect output regulated voltage, over voltage and over current is to cascade a linear regulator with overheat protection at input or output terminal, and connect a capacitor filter net(see below picture), filter capacitive value recommended see table 1, Linear regulator is chosen according to the actual voltage, current needed in working, or choose our NW series products.

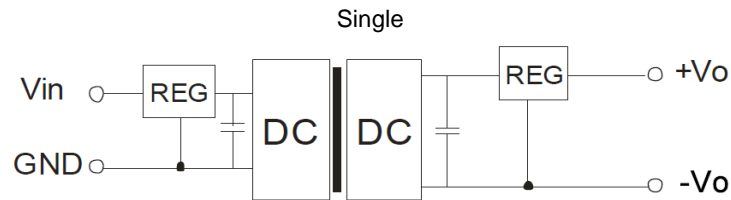

Note:

1. This product cannot be used in parallel, and do not support hot-plugging;
2. If the product works below the minimum required load, it cannot guarantee that the product performance meets all performance indicators in this manual;
3. All index testing methods in this datasheet are based on our Company's corporate standards
4. The product specification may be changed at any time without prior notice.