

Power terminals

Technical specifications	184
Hole specifications	185
Power terminal grid 5.08 x 7.62 mm	186
Power terminal grid 5.08 x 10.16 mm	188
Blade connector	190
Accessories	191

Technical specifications

Technical specifications			
	Grid 5.08 x 7.62 mm	Grid 5.08 x 10.16 mm	Blade connector
Operating temperature range	- 55 °C to + 125 °C		
Current carrying capacity at ambient temperature			
20 °C	45 A	45 A	25 A
70 °C	30 A	30 A	20 A
100 °C	25 A	25 A	15 A
The operational current is determined by the printed circuit board, the cable diameter, and the cable lug used (values when using a 6 mm ² cable).			
Insertion force	Type 150 N/pin	Type 150 N/pin	max. 300 N/pin
Retention force	min. 60 N/pin	min. 60 N/pin	min. 60 N/pin
Plating	2 – 8 µm Sn	2 – 8 µm Sn	2 – 8 µm Sn
Thread	M4 or M5	M4	–
Max. tightening torque	1.3 Nm	1.3 Nm	–
Environment	RoHS compliant		

Current carrying capacity

The connection is made by means of commercially available cable lugs, or with the variants by means of a plug connection or optionally using a flat blade connection (FASTON).

The operational current is determined by the printed circuit board, the cable diameter, and the cable lug used.



Hole specifications

Plated through-hole according to IEC 60352-5

			Grid 5.08 x 10.16 mm	Grid 5.08 x 7.62 mm
		Nominal hole	Ø 1.45 mm	Ø 1.6 mm
Imm. Sn printed circuit boards				
	A	PCB thickness	min. 2.9 mm	min. 2.9 mm
	B	Plated hole	$\text{Ø } 1.45 + 0.09/-0.06 \text{ mm}$	$\text{Ø } 1.6 + 0.09/-0.06 \text{ mm}$
	C	Drill hole	$1.6 \pm 0.025 \text{ mm}$	$1.75 \pm 0.025 \text{ mm}$
	D	Cu plating	min. 25 μm	min. 25 μm
	E	Imm. Sn plating	max. 1.5 μm	max. 1.5 μm
	F	Annular ring	min. 0.1 mm	min. 0.1 mm
Ni, Au printed circuit boards				
	A	PCB thickness	min. 2.9 mm	min. 2.9 mm
	B	Plated hole	$\text{Ø } 1.45 + 0.09/-0.06 \text{ mm}$	$\text{Ø } 1.6 + 0.09/-0.06 \text{ mm}$
	C	Drill hole	$1.6 \pm 0.025 \text{ mm}$	$1.75 \pm 0.025 \text{ mm}$
	D	Cu plating	min. 25 μm	min. 25 μm
	E	Ni, Au plating	0.05 – 0.2 μm Au over 2.5 – 5 μm Ni	0.05 – 0.2 μm Au over 2.5 – 5 μm Ni
	F	Annular ring	min. 0.1 mm	min. 0.1 mm
HAL Sn printed circuit boards				
	A	PCB thickness	min. 2.9 mm	min. 2.9 mm
	B	Plated hole	$\text{Ø } 1.45 + 0.09/-0.06 \text{ mm}$	$\text{Ø } 1.6 + 0.09/-0.06 \text{ mm}$
	C	Drill hole	$1.6 \pm 0.025 \text{ mm}$	$1.75 \pm 0.025 \text{ mm}$
	D	Cu plating	min. 25 μm	min. 25 μm
	E	HAL Sn	5 – 15 μm	5 – 15 μm
	F	Annular ring	min. 0.1 mm	min. 0.1 mm

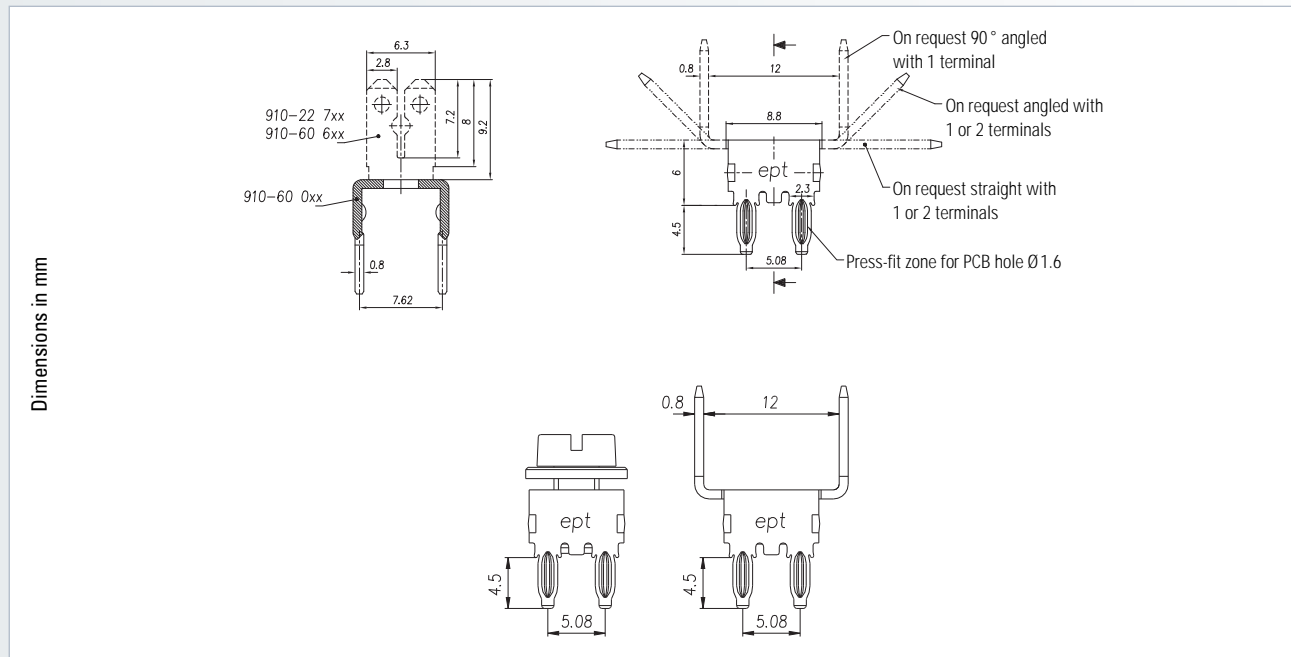

Power terminals
5.08 x 7.62 mm

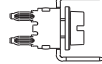
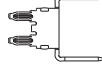
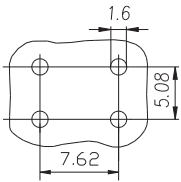

Pins	Contact arrangement	Press-fit technology – thread M4			
					
Part number					
4		910-60045	910-22015	910-60645/1	910-22715/1

<p>Accessories</p> <ul style="list-style-type: none"> – Screws DIN 84 (see page 191) – Washer (see page 191) – Lock nut (see page 191) – Philips screw (see page 191) – Press-fit tool (see page 216) – Support tool (see page 217) 	<p>On request</p> <ul style="list-style-type: none"> – With 1 or 2 terminals angled – With 1 or 2 terminals straight – With 1 terminal 90°
--	--

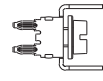
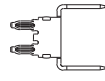
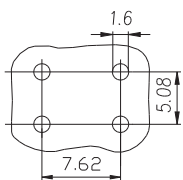

Pins	Contact arrangement	Press-fit technology – thread M5			
					
		Part number			
4		910-60050	910-22020	910-60650/1	910-22720/1

Accessories

- Screws DIN 84 (see page 191)
- Washer (see page 191)
- Lock nut (see page 191)
- Press-fit tool (see page 216)
- Support tool (see page 217)

On request

- Philips screw
- With 1 or 2 terminals angled
- With 1 or 2 terminals straight
- With 1 terminal 90°

Power terminals
5.08 x 10.16 mm

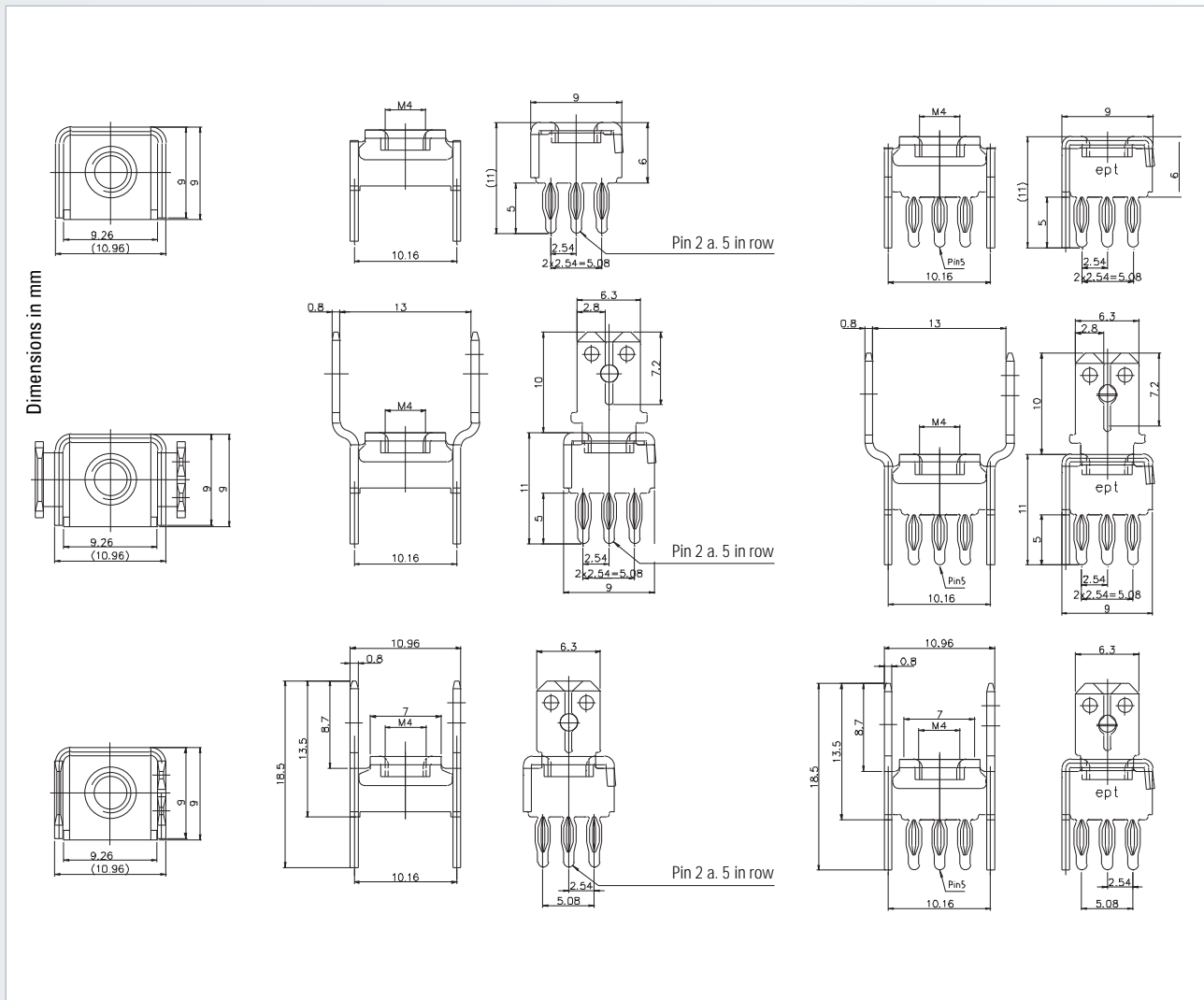

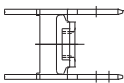
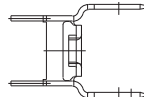
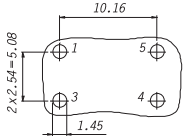
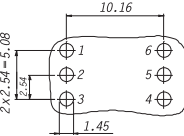
		Press-fit technology – thread M4		
Pins	Contact arrangement			
		Part number		
4		911-32004	911-32244	911-32044
6		911-32006	911-32246	911-32046

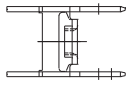
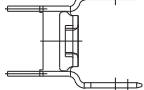
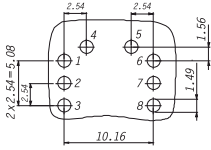
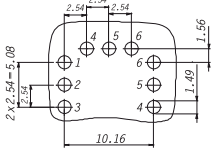

Pins	Contact arrangement	Press-fit technology – thread M4		
				
		Part number		
8		911-33008	911-33248	911-33048
9		911-33009	911-33249	911-33049

Accessories

- Screws DIN 84 (see page 191)
- Washer (see page 191)
- Philips screw (see page 191)
- Press-fit tool (see page 216)
- Support tool (see page 217)

Power terminals
Blade connector

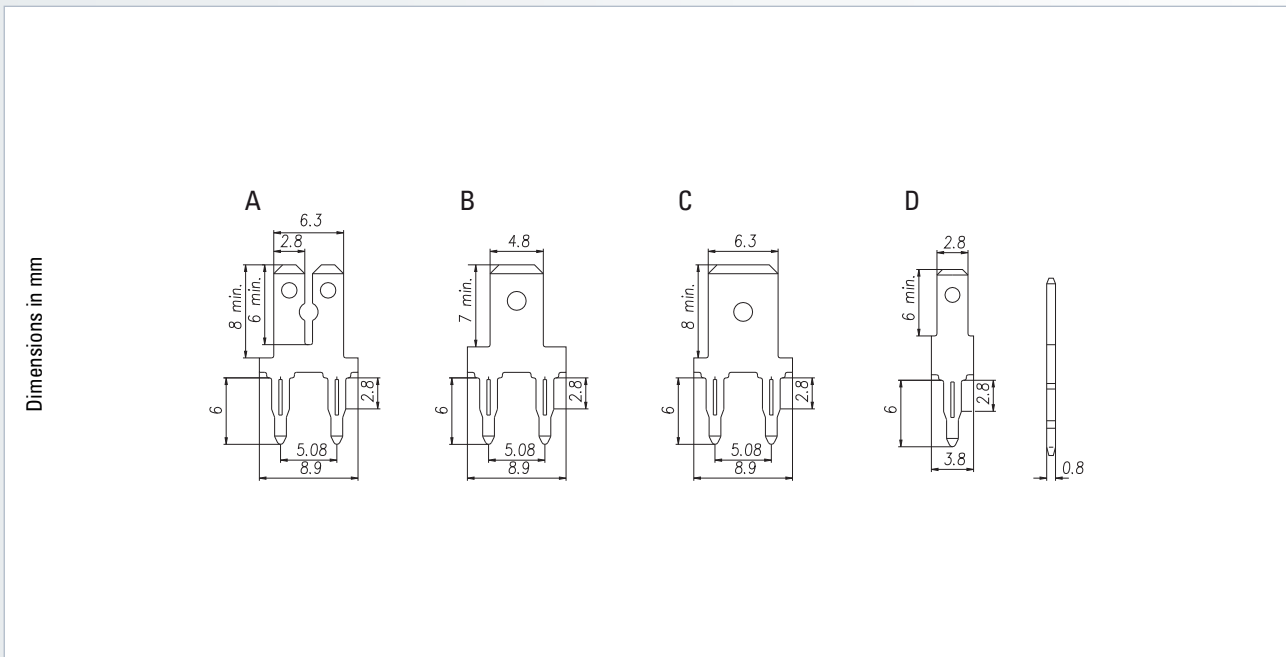

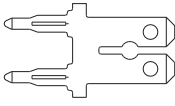
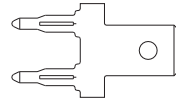
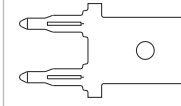
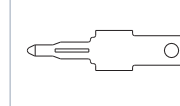
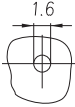
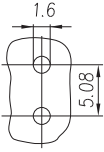
Pins	Contact arrangement	Press-fit technology			
		A	B	C	D
					
Part number					
1		-	-	-	090-10164
2		090-10162	090-10161	090-10163	-





Accessories

- Press-fit tool (see page 216)
- Support tool (see page 217)

Note

- Plated hole $\varnothing 1.6 + 0.04/-0.06$ mm (solid pin)



Thread	Side view	Part number	
		M4	M5
Socket cap screw DIN 84		910-20145	910-20150
Philips screw		910-20146	–
Washer		910-20320	910-20330
Lock nut		910-20015	910-20020

On request
– Philips screw in M5